



Quality Products. Service Excellence.

Audio Broadcast Quality 850A Series

Sealed

Features



- Deep-drawn steel case with tin plated finish, with two convenient 6-32 mounting studs with mounting hardware.
- Sealed case and wax potted core internally for stable characteristics and long life.
- Wide frequency response +/- 0.5 db max. from 20 Hz. to 20 Khz. (except units over 5K ohms impedance, may be down 1 db @ 20 Khz.)
- Insertion loss of apx. 1 db.
- Maximum power level +15 dbm. with specified characteristics, or higher levels with reduced low frequency performance.
- Distortion is apx. 1.5% @ 20 Hz. under full power.
- Electrostatic shield between pri. & sec. connected to the green lead.
- Humbucking construction
- Balanced split windings on pri. & sec. for circuit versatility. Primary may be used as a secondary and vice versa for impedance matching.
- Includes mounting hardware.
- Lead length: Min. 4"
- Shipping weight 0.4 lb. (0.18 kg).



RoHS

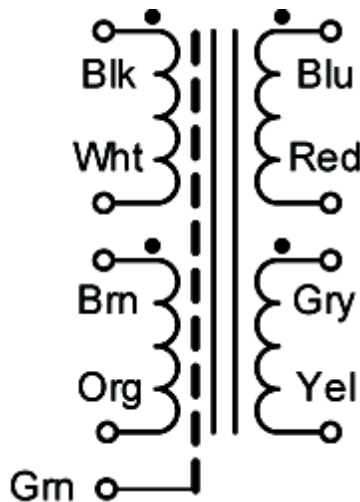
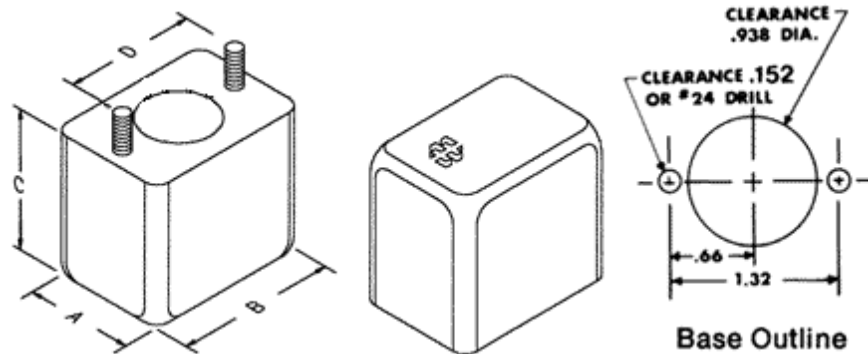

Part No.	Application	Nominal Impedance (Ohms)		Nominal Resistance (Ohms) +/- 20%		Overall Dimensions			
		Primary	Secondary	Primary	Secondary	A	B	C	D
850CA	Emitter or MIC to Line	12/48	150/600	6	70	1.20	1.70	1.65	1.32
850EA	Emitter or MIC to Line	50/200	150/600	27	68	1.20	1.70	1.65	1.32
850GA	Line Isolation or Hybrid	150/600	150/600	71	71	1.20	1.70	1.65	1.32
850HA	Line Isolation or Hybrid	150/600	300/1200	70	140	1.20	1.70	1.65	1.32
850JA	Output to Line, or Line to Base	150/600	1200/4800	69	570	1.20	1.70	1.65	1.32
850LA	Output to Line, Matching or Bridging	5K/20K	150/600	2240	69	1.20	1.70	1.65	1.32
850NA	Output to Line, Matching or Interstage	150/600	10K/40K	65	4980	1.20	1.70	1.65	1.32
850QA	Interstage or Isolating	10K/40K	10K/40K	4890	4980	1.20	1.70	1.65	1.32

Data subject to change without notice

© 2021. Hammond Manufacturing Ltd. All rights reserved.