

PARTS LIST LISTE DES PIÈCES

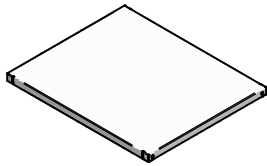

ITEM 1
RCHS TOP
QTY 1

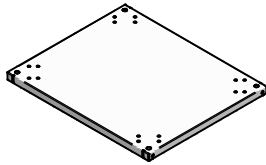

ITEM 2
RCHS BOTTOM
QTY 1

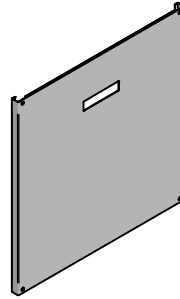

ITEM 3
RCHS SIDES
QTY 2



ITEM 4
RSHS RAILS
QTY 4



ITEM 5
HANDLE
QTY 2

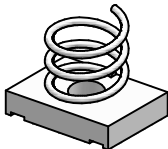

ITEM 6
1/4-20 SPRING NUT
QTY 8

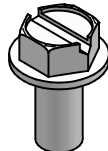

ITEM 7
1/4-20 BOLT
QTY 8



ITEM 8
M6 SCREW
QTY 8



ITEM 9
RUBBER FEET
QTY 4

1

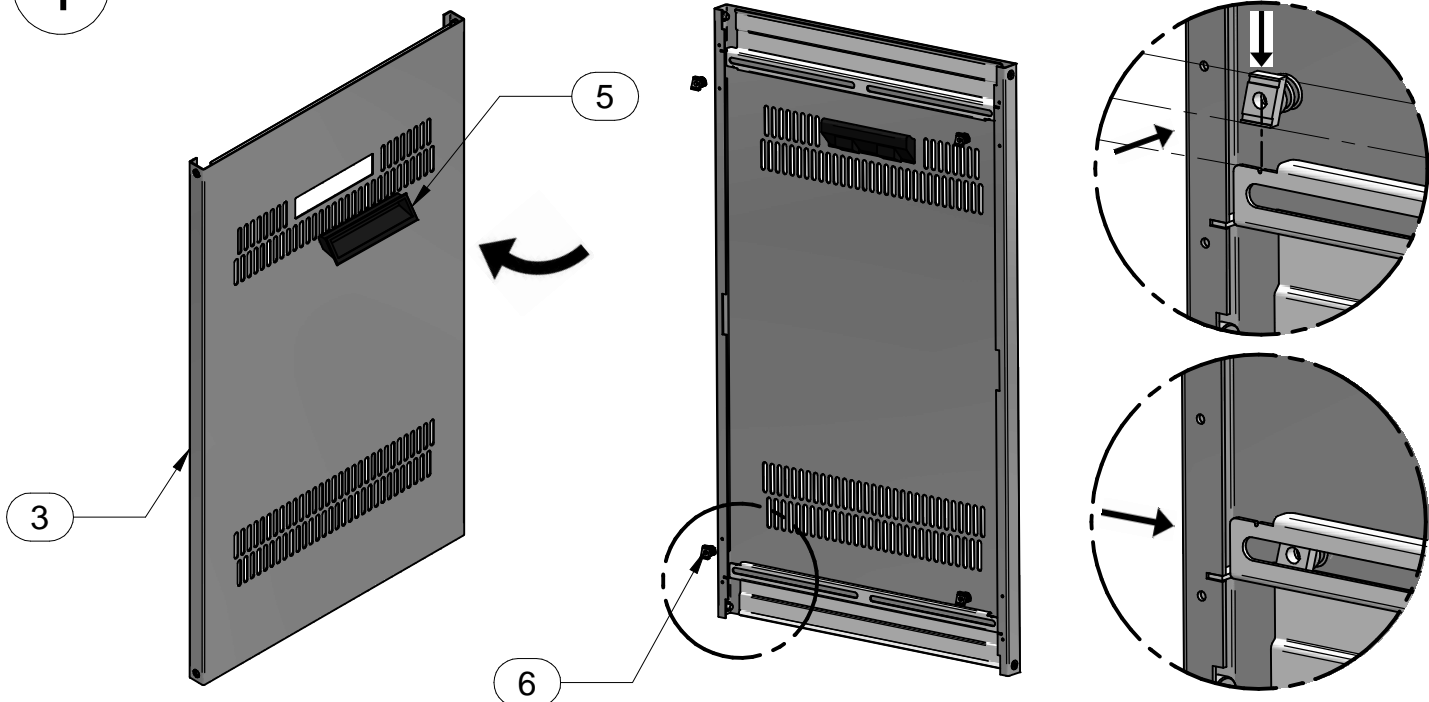

TOOL BOX



BOÎTE À OUTILS



3/8



visit our website:
visitez notre site Web:

www.hammondmfg.com

2

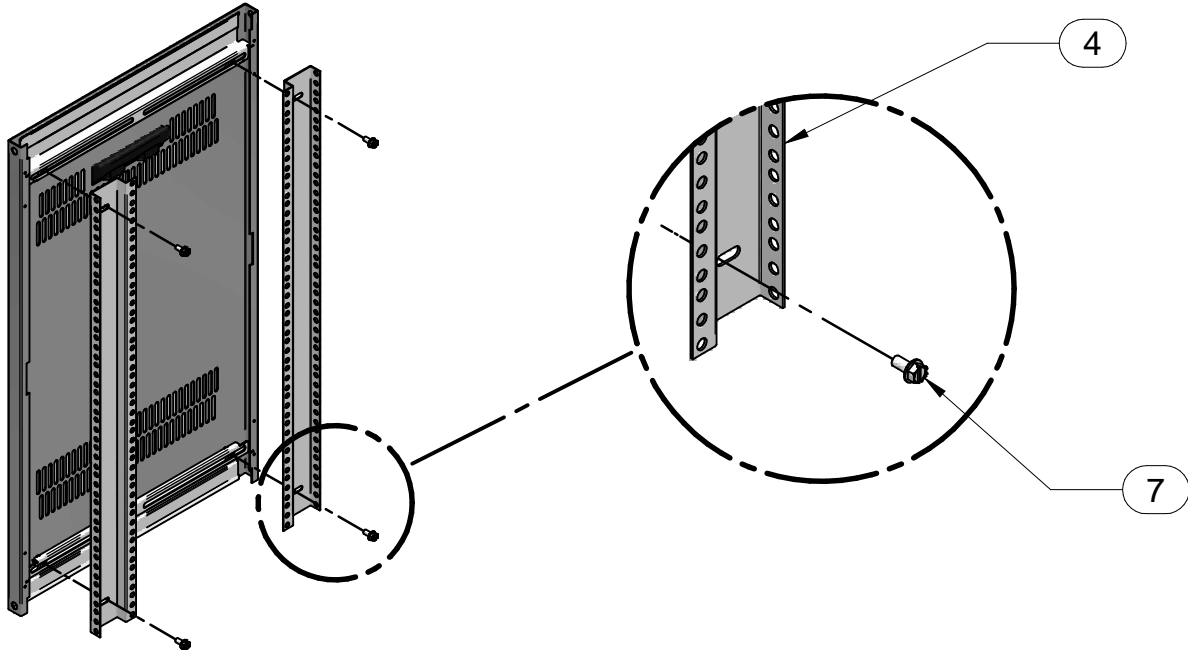

3

