

1140-LU-BPC

PRINTED CIRCUIT BOARD MOUNT LINE OUTPUT TRANSFORMER

This transformer is designed with bi-filar windings and a 49% Ni core, which gives low distortion levels and good output levels.

It can drive 600 Ω loads up to +21dbu @ 20Hz.

Due to the properties of the Ni core, the drive signal should have no DC component and the source impedance should be as low as possible.

ELECTRICAL SPECIFICATIONS

Characteristic	Conditions	Typical
Input Impedance		600 Ω
Output Impedance		600 Ω
Primary Input Impedance	@ 1kHz 0dbu Test Circuit 3	710KΩ
Secondary Output Impedance	@ 1kHz 0dbu Test Circuit 4	115Ω
Maximum input Level	@ 20Hz RL = 600	+21 dbu
DCR		
Primary	@20°C	58 Ω
Secondary	@20°C	58 Ω
Frequency Response	@ 20 Hz, 0 dbu, Test Circuit 3	-0.20db
	@ 20 kHz, 0 dbu, Test Circuit 3	+0.03db
Turns ratio		1:1
Common Mode Rejection Level	@ 60 Hz, 0 dbu, Test Circuit 2	105db
	3kHz, 0 dbu, Test Circuit 2	70db
THD	@ 1kHz 4 dbu Test Circuit 1	0.002%
	@ 20Hz 4 dbu Test Circuit 1	0.15%
Phase Shift	@ 20 Hz Test Circuit 1	0.5°
	@ 20 kHz Test Circuit 1	-1.0°
Capacitance	Primary to Shield and Case	20nf
	Secondary to Shield and Case	45pf
Dielectric Strength		250 Vrms

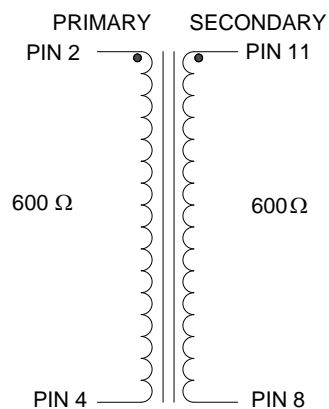
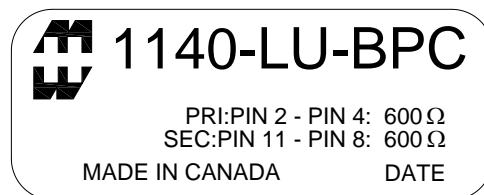
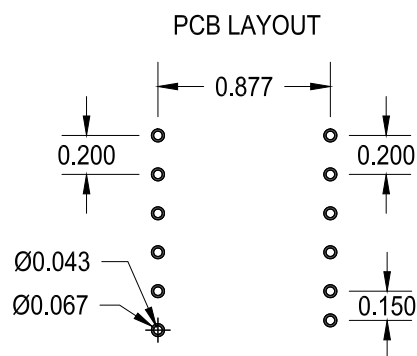
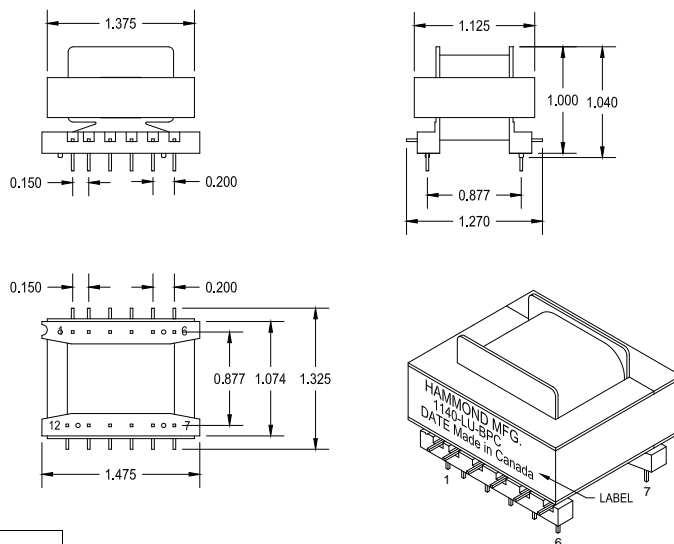

1140-LU-BPC FREQUENCY RESPONSE

Input Level 0 dBu
Rs = 0Ω, RL = 600Ω

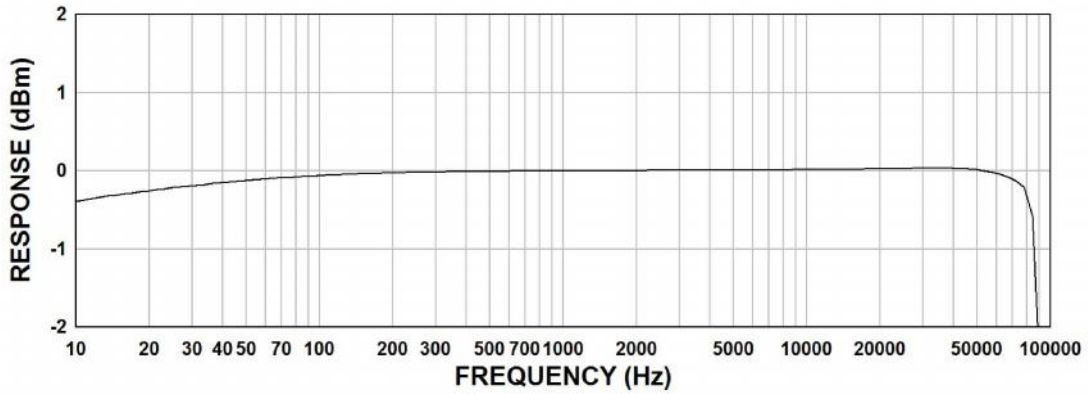

1140-LU-BPC PHASE SHIFT

Input Level 0 dBu
Rs = 0Ω, RL = 600Ω

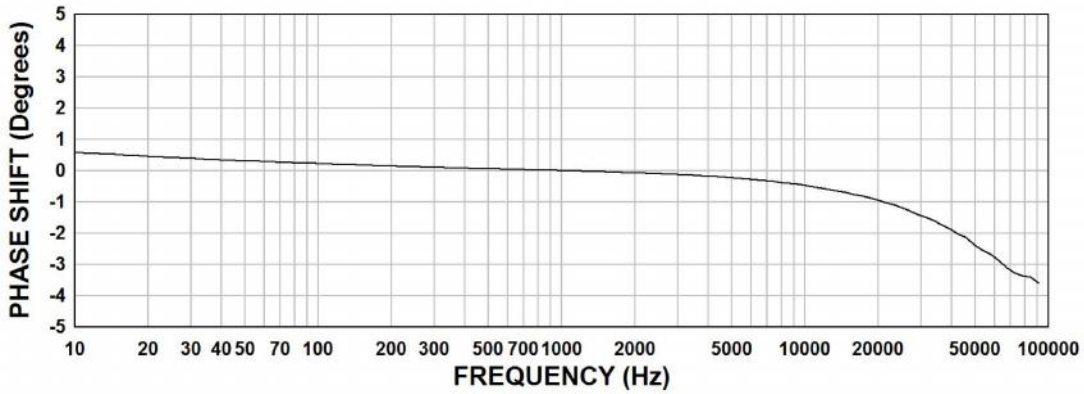

1140-LU-BPC THD+N

Input Level +4dBu
Rs = 0Ω, RL = 600Ω

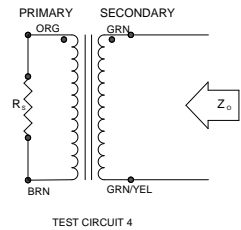
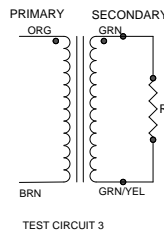
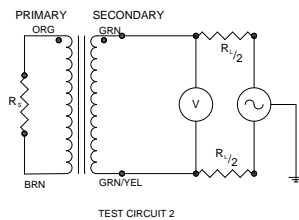
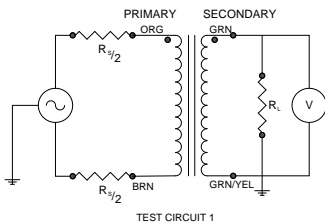
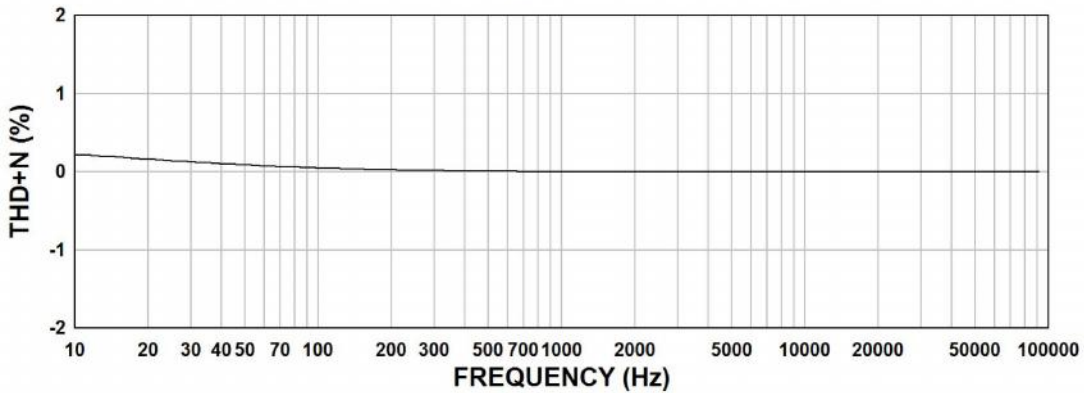

Measurement instruments
 Hp4192a impedance analyzer
 Hp3456a DVM
 Keithley 2002 DVM
 D scope series iii audio analyzer

This drawing and the information in it is the property of Hammond Manufacturing. It may not be reproduced, transmitted or used in any manner whatsoever without the written permission of Hammond Manufacturing. Data subject to change without notice.