

EXTRUSION

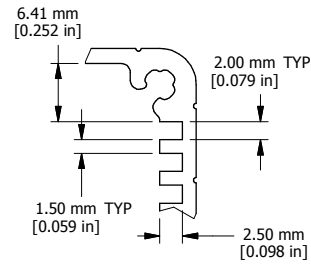

DETAIL A

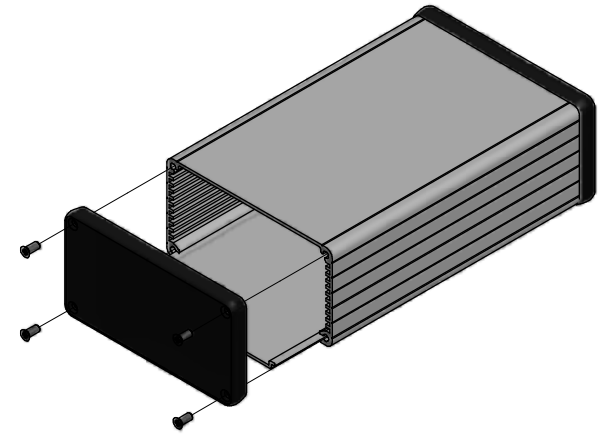

EXPLODED ASSEMBLY VIEW

EXTRUSION DESIGNED FOR 100MM WIDE PC BOARD

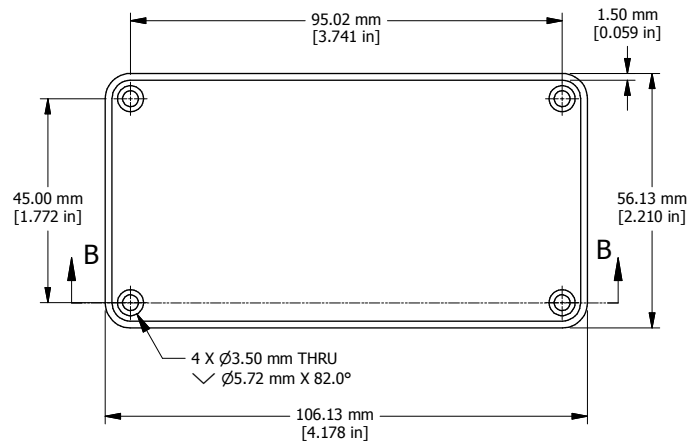

CLOSED BEZEL

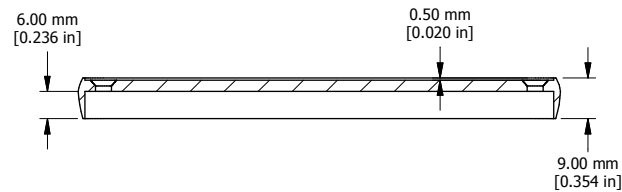

Enclosures can be Factory Modified (Milling, Drilling, Printing etc.)
 Solid models of this enclosure available in STEP or IGES.
 Contact Factory mjm@hammondmfg.com

NOTE

Purchased assembly includes box, plastic bezels, #6 Taptight screws and self adhesive rubber feet.

Box made from Extruded Aluminum 6063.

Bezels made with ABS.

1455N1602

PART NUMBERS

Clear Anodized	1455N1602
Black Anodized	1455N1602BK

ACCESSORIES

See website for accessories.

