

END VIEW

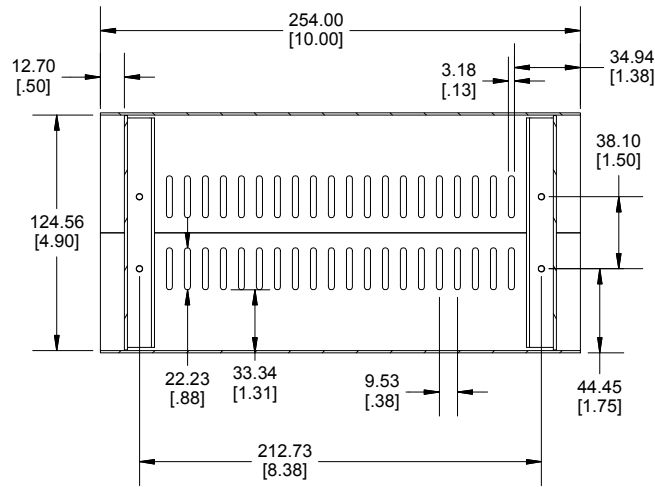

**SECTION A-A
SIDE VIEW**

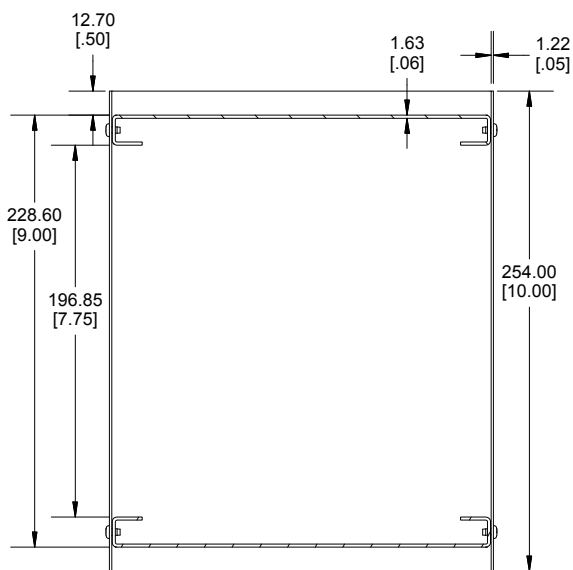
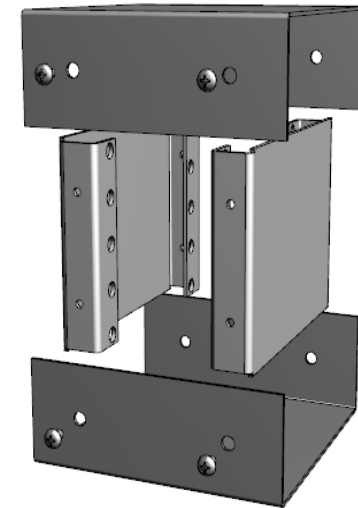

**SECTION B-B
TOP VIEW**

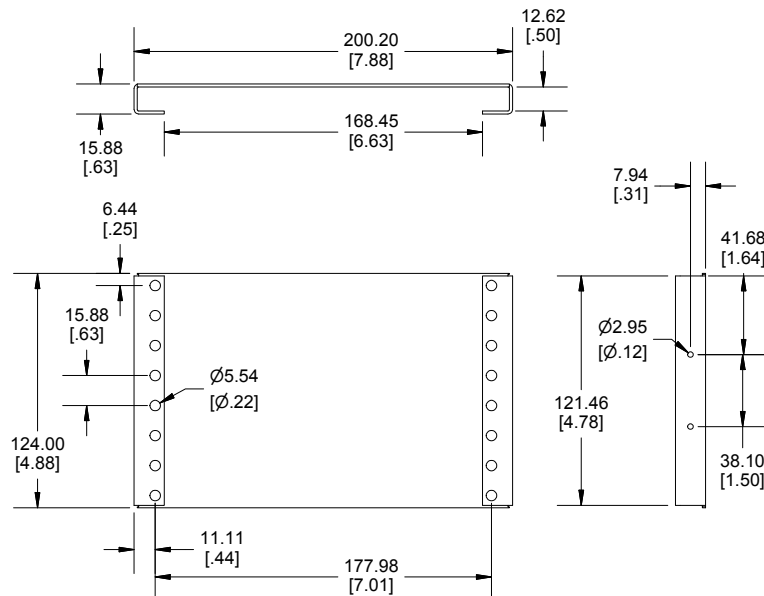

END PLATE

Enclosures can be Factory Modified (Milling, Drilling, Printing etc.)
 Contact Factory (modshop@hammondmfg.com) for quotes
 Solid models of this enclosure available in .stp or .x_t
 (Part number and text placement/orientation on our products are subject to change,
 we do not recommend using them as a locating reference for modification purposes)

NOTE

Purchased assembly includes Top, Bottom, Black End Plate, Grey End Plate,
 8 Enclosure screws, and 4 Rubber feet.

Recommended Cover screw torque 125-150 cN-m (11-13.3 lbf-in)

1458

1458 Regular Enclosure

Top / Bottom powder coated Gulf Blue RAL 5021	1458VE5B
Top / Bottom powder coated Black RAL 9011	1458VE5
ACCESSORIES	
Nickel plated Enclosure screws [#6-32 x 1/4"] Self-Tapping (Pkg 8)	1421J8
Rubber Feet (Pkg 24)	1421T3

Dimensions:
 mm
 [inches]

**HAMMOND
 MANUFACTURING**
1458VE5
 www.hammondmfg.com