

SECTION A-A
(VIEW FROM FRONT)

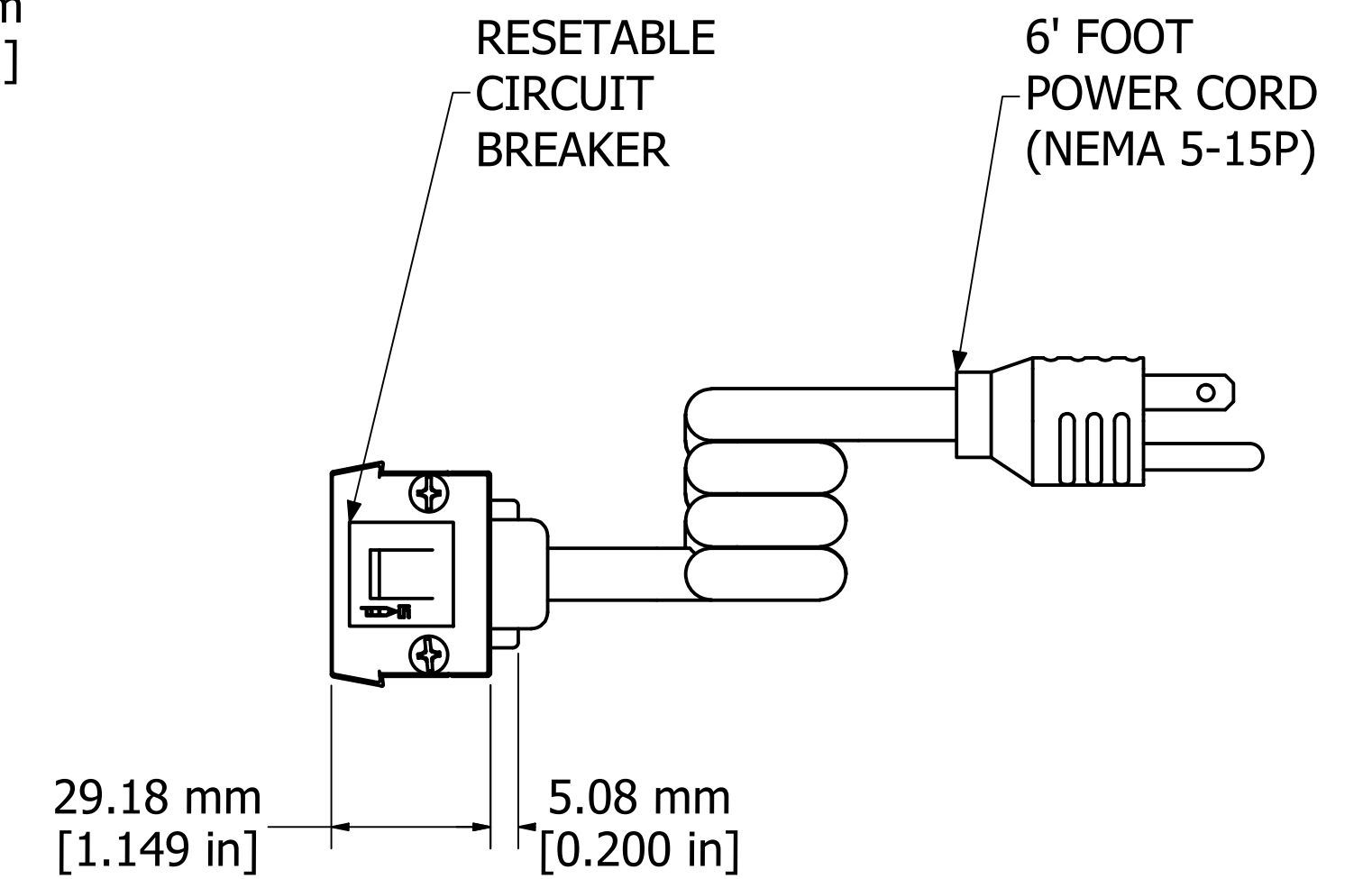

ASSEMBLY - VIEW FROM END

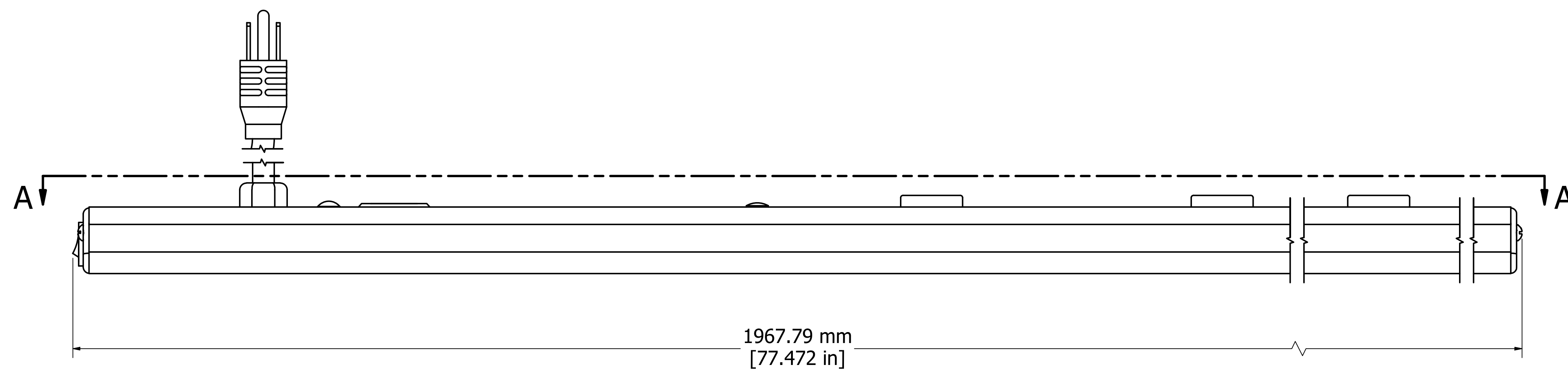

ASSEMBLY - VIEW FROM SIDE

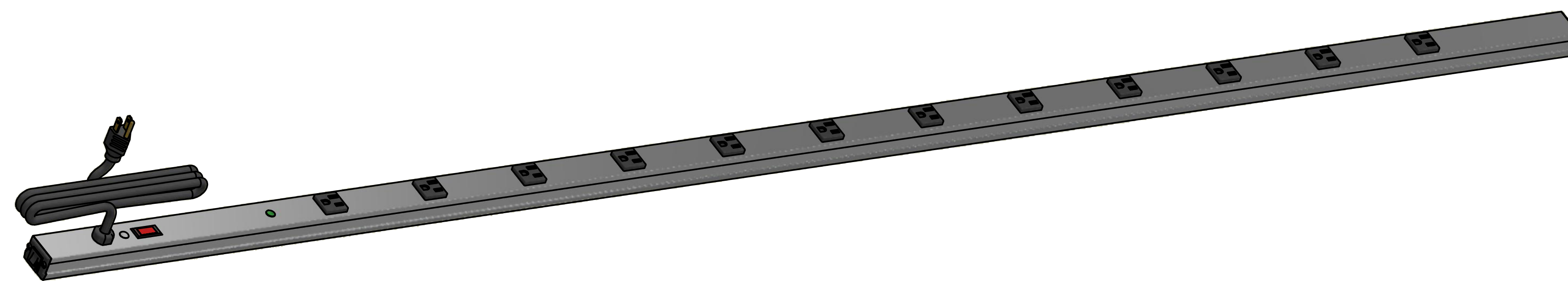

ISOMETRIC VIEW

1588T12A1S
Finish - Case - Anodized Aluminum Extrusion
Ends - ABS Plastic
Rated - 125 VAC, 60 Hz, 15 Amps
Approvals - cULus Listed to: UL1449 & C22.2 No. 269.3-17
Surge Specs - 1080 Joules, 75000 Amps Transient Current - 500V Voltage Protection Rating (VPR)
Accessories Included
Mounting Bracket Kit with Hardware

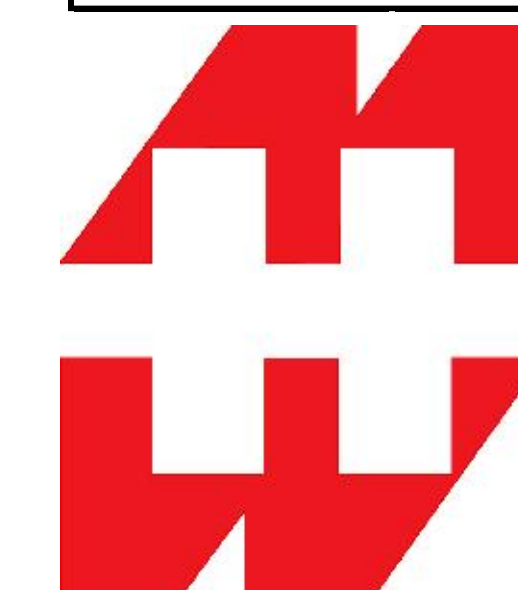

**HAMMOND
MANUFACTURING™**

1588T12A1S

www.hammondmfg.com