

TOP VIEW

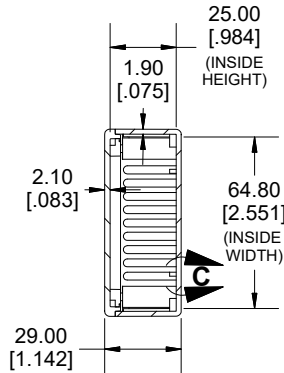

SECTION A-A

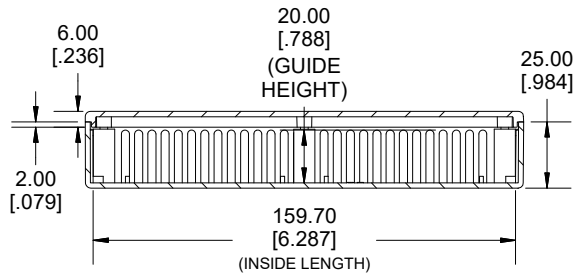
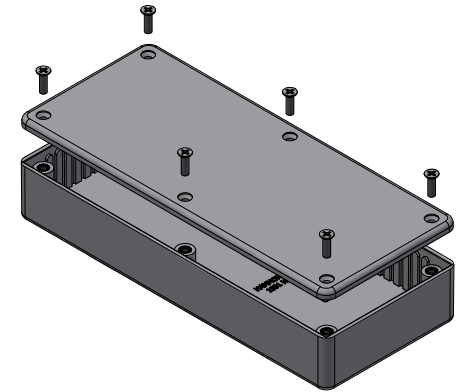

SECTION B-B
SIDE VIEW

DETAIL C

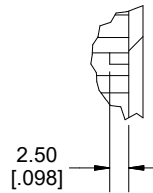

DETAIL D

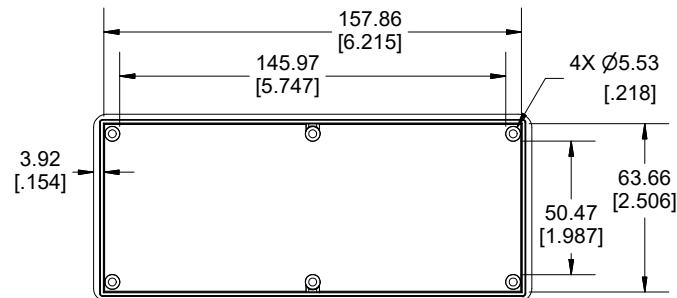
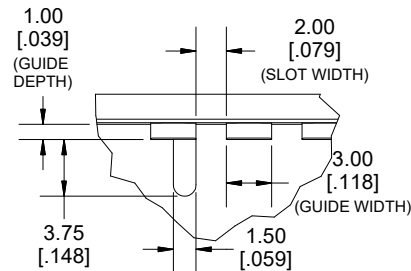

INSIDE LID

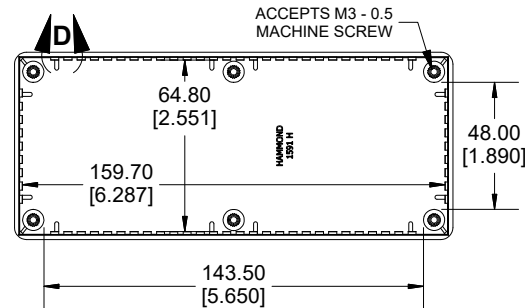

INSIDE BOX

Dimensions:
mm
[inches]

Enclosures can be Factory Modified (Milling, Drilling, Printing etc.)
Contact Factory (modshop@hammfg.com) for quotes
Solid models of this enclosure available in .stp or .x_t
(Part number and text placement/orientation on our products are subject to change, we do not recommend using them as a locating reference for modification purposes)

NOTE	
Purchased assembly includes box, lid, 6 cover screws, and pre-installed brass inserts.	
Enclosure made from FRABS or Polycarbonate.	
Recommended Torque: 35.5-42.5 ozf.in (25-30 cN.m)	

PART NUMBERS		
1591H Enclosure		
Material	Colour	Part Number
FR ABS UL94 -V0	Beige	1591HBG
	Black	1591HBK
	Blue	1591HBU
	Grey	1591HGY
Accessories		
Plated Cover screw		1591MS100 (Silver)
M3 - 0.5 X 10mm (100Pkg)		1591MS100BK (Black)
PC Board Card Adapters		1591Z6 (6Pkg)
		1591Z50 (50 Pkg)
		1591Z100 (100Pkg)
Nylon Belt / Pocket clip		1599CLIP (Black)
		1599CLIPGY (Grey)
Clear Lids - Flame Retardant Polycarbonate - Lid ONLY		1591HC

**HAMMOND
MANUFACTURING.**
1591H
www.hammondmfg.com