

DIMENSIONS:	
A	1.951" ±0.031
B	1.438" ±0.031
C	1.688" ±0.063
D	0.018" X 0.041" ±0.005
E	1.300" ±0.031
F	0.188" X 0.030" ±0.005
G	0.250" ±0.031
H	1.891" ±0.031
J	0.570" ±0.031

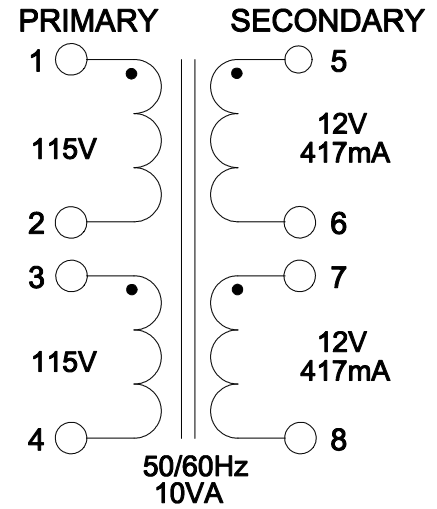
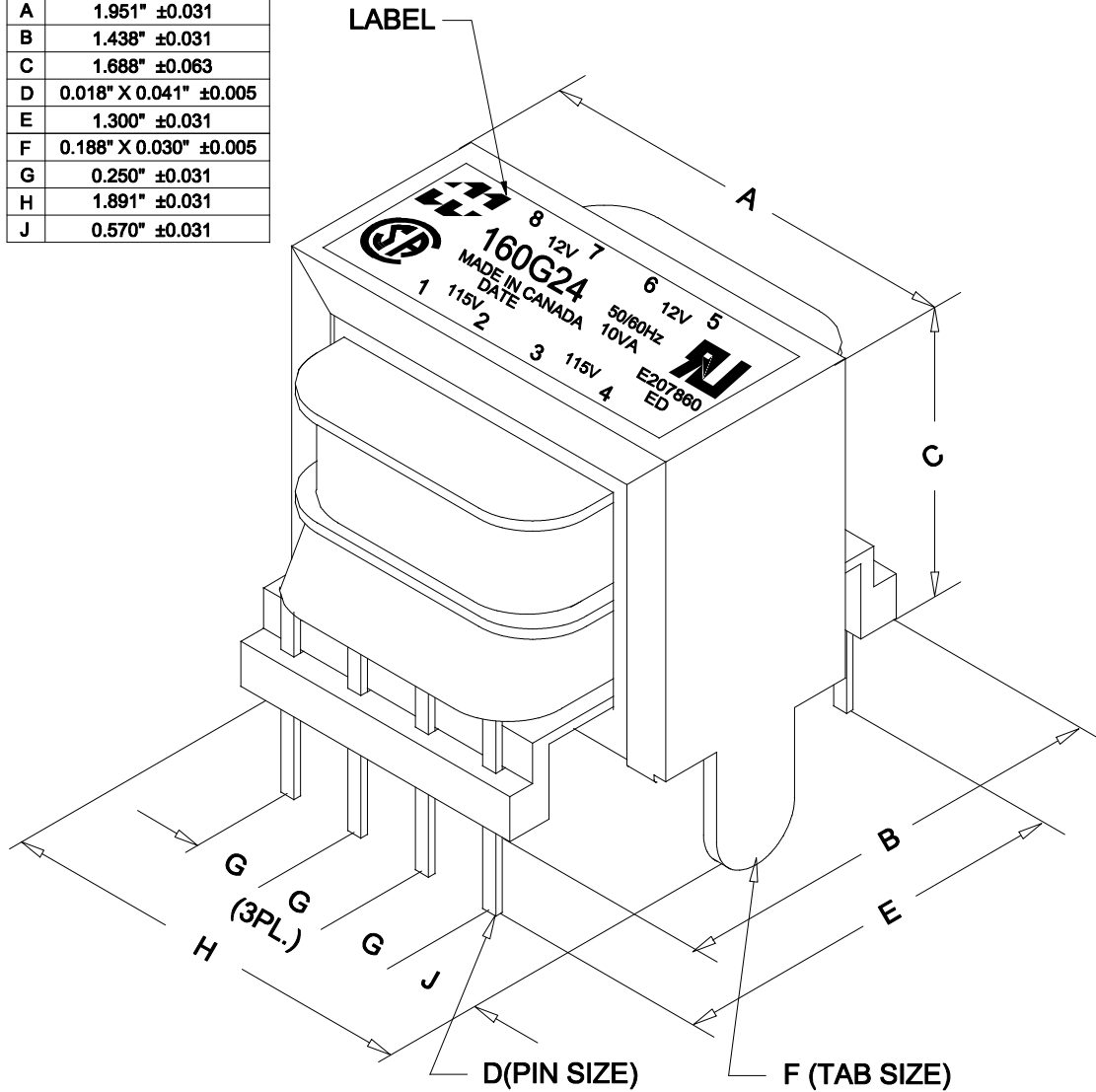

ELECTRICAL DATA:		
TESTS	CONDITIONS	ACCEPTANCE CRITERIA
lex	@ 115V, 60Hz, PIN 1 - PIN 2	52.8mA Max.
Sec. N.L.V	@ 115V, 60Hz, PIN 1 - PIN 2	
	PIN 3 - PIN 4 =	115.0V ±2%
	PIN 5 - PIN 6 =	14.82V ±2%
	PIN 7 - PIN 8 =	14.82V ±2%
DCR	@ 20°C, PIN 1 - PIN 2 =	138.2 Ω ±20%
	@ 20°C, PIN 3 - PIN 4 =	165.3 Ω ±20%
	@ 20°C, PIN 5 - PIN 6 =	2.483 Ω ±20%
	@ 20°C, PIN 7 - PIN 8 =	2.483 Ω ±20%
HIPOT	PRIMARY - SECONDARY	2000V, 60Hz, 1 SEC

REV.#	REVISION	DATE
0	RELEASED.	C.I. 06/08/22

HAMMOND MANUFACTURING™	ELECTRONIC DIVISION 52 RANKIN PLACE, WATERLOO, ONTARIO, N2J 3Z5		PH # (519) 886-6181 FAX # (519) 886-9540
	DWG. BY: C. ILIE DATE: 06/08/22	CHK'D BY: APP'D. BY: DIMENSIONS: IN(X) MM()	TITLE: PC BOARD MOUNT POWER TRANSFORMER