

DIMENSIONS:	
A	0.300" ±0.030
B	0.400" ±0.030
C	1.590" ±0.030
D	0.041" x 0.018" ±0.005
E	1.110" ±0.030
F	0.040" ±0.005
G	0.234" ±0.005

DIMENSIONS:	
H	1.410" ±0.030
J	0.340" ±0.030
K	0.660" ±0.030
L	2.250" ±0.030
M	0.390" ±0.030
N	1.460" ±0.030
W	1.875" ±0.030

DIMENSIONS:	
P	0.125" ±0.015
Q	1.500" ±0.030
R	0.125" ±0.015

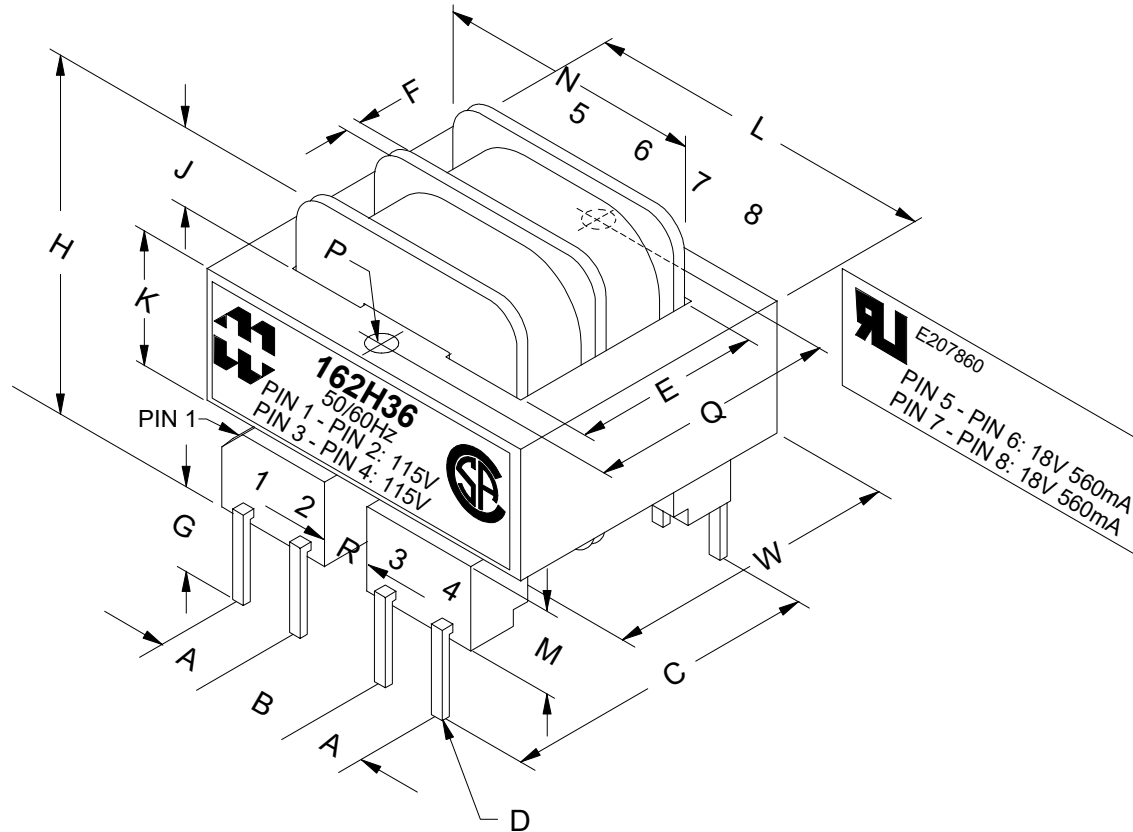
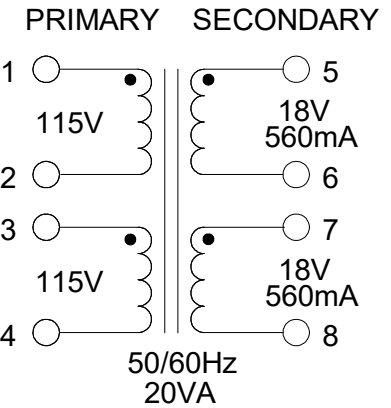

PIN #'S EMBOSSED ON BOBBIN FLANGE

ELECTRICAL DATA:		
TESTS	CONDITIONS	ACCEPTANCE CRITERIA
lex	@ 115V, 60Hz, PIN 1 - PIN 2	91.2mA Max.
Sec. N.L.V	@ 115V, 60Hz, PIN 1 - PIN 2	
	PIN 3 - PIN 4 =	115.0V ±2%
	PIN 5 - PIN 6 =	21.64V ±2%
	PIN 7 - PIN 8 =	21.64V ±2%
DCR	@ 20°C, PIN 1 - PIN 2 =	69.51 Ω ±20%
	@ 20°C, PIN 3 - PIN 4 =	69.51 Ω ±20%
	@ 20°C, PIN 5 - PIN 6 =	2.550 Ω ±20%
	@ 20°C, PIN 7 - PIN 8 =	2.550 Ω ±20%
HIPOT	PRIMARY - SECONDARY	2500V, 60Hz, 1 SEC

REV.#	REVISION	DATE
0	RELEASED.	C.I. 03/27/24



ELECTRONIC DIVISION
 52 RANKIN PLACE,
 WATERLOO, ONTARIO, N2J 3Z5

PH # (519) 886-6181
 FAX # (519) 886-9540

DWG. BY: C. ILIE	CHK'D BY:
DATE: 03/27/24	APP'D. BY:
DIMENSIONS: IN(X) MM ()	

TITLE: PC BOARD MOUNT
 POWER TRANSFORMER

DWG. NO.
 162H36