

Low Voltage P.C. Board Mounted Power Transformer

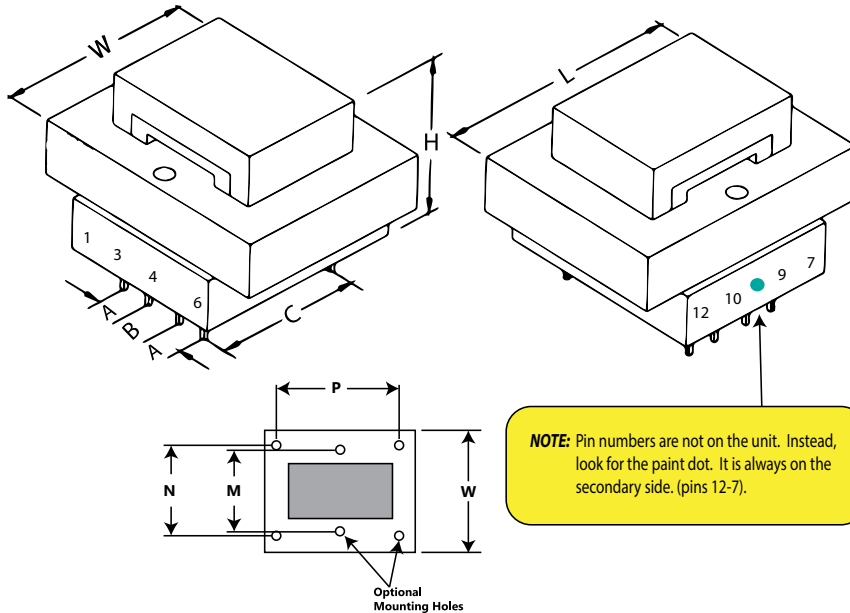

Key Features:

- Universal operation on 50/60Hz, 115 or 230V dual primary for worldwide use.
- Low Profile, split bobbin with top shroud design
- Dual winding secondary, non-concentrically wound.
- Low Primary to secondary coupling with no electro-static shield required.
- High Insulation - Hipot of 4,000V RMS
- Class F Insulation - 155 degrees C.
- P.C. Board mount with industry standard pin spacing.
- Agency listings: cURus, CE, and TUV.

Mechanical - inches (mm)	
L	3 (76.2)
W	2.5 (63.5)
H	1.81 (46)
A	0.6 (15.2)
B	0.3 (7.6)
C	1.9 (48.3)
M	- (-)
N	2 (50.8)
P	2.5 (63.5)
Pin Size	0.045 (1.1)
Screw Type	#6
Weight	1.7 lbs. / 0.77 kg
Electrical	
Size (VA)	56
Primary	115 / 230 VAC
Sec (Series)	36V C.T. @ 1.56A
Sec (Parallel)	18V @ 3.12A

Connection Information 183 Series Power Transformers

Primary Connections - 183 Series Transformers

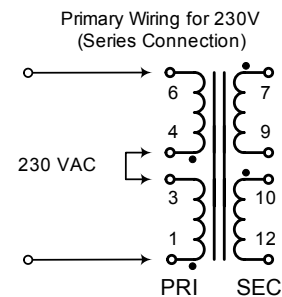
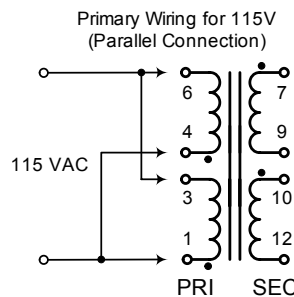

Secondary Connections - 183 Series Transformers

