

ASSEMBLY - VIEW FROM FRONT

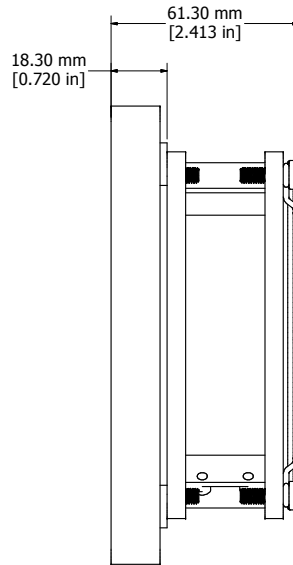

ASSEMBLY - VIEW FROM SIDE

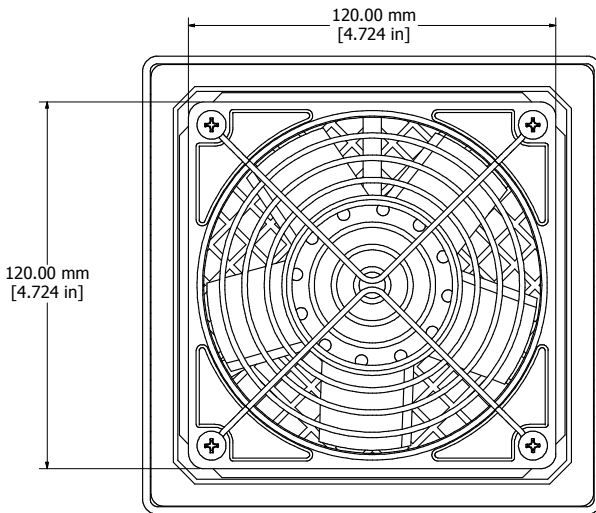

ASSEMBLY - VIEW FROM BACK

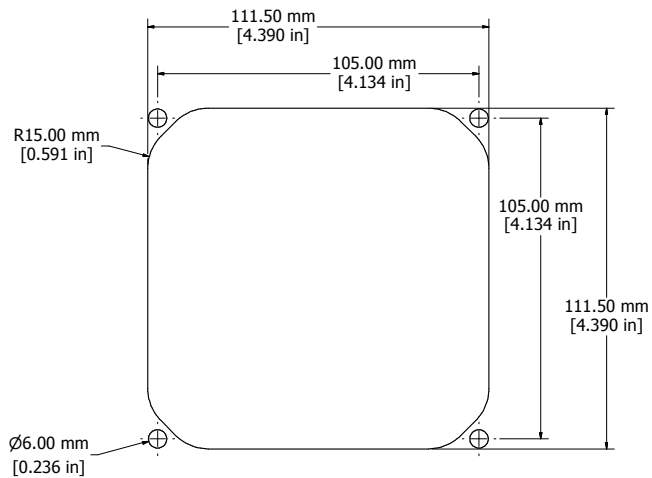
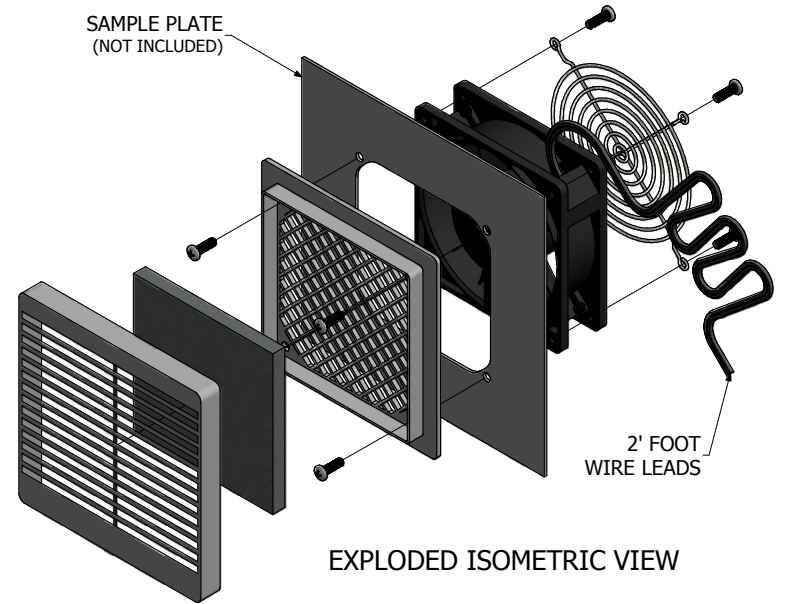

PLATE CUTOUT



EXPLODED ISOMETRIC VIEW

DNFF120**115
Finish - Front Screen - ABS Plastic
- Back Panel - ABS Plastic
Rated - 115 VAC, 50/60 Hz, 0.19 Amps
Free Flow Air Delivery - 105 CFM
Colours
DNFF120BK115 - Black
DNFF120CG115 - Gray/Beige
DNFF120GY115 - Gray
DNFF120LG115 - Light Gray
Hardware
8 Screws - Panhead Self-tapping 10-32 x 1/2"
4 Speed Nuts
Accessories
PFF2000 - Standard Filter Media (Pkg of 5)
PLFF2000 - Pleated Filter Media (Pkg of 5)

