

DIMENSIONS:	
A	2.375" ±0.063
B	1.600" ±0.125
C	1.995" ±0.063
D	2.000" ±0.063
G	0.187" ±0.015

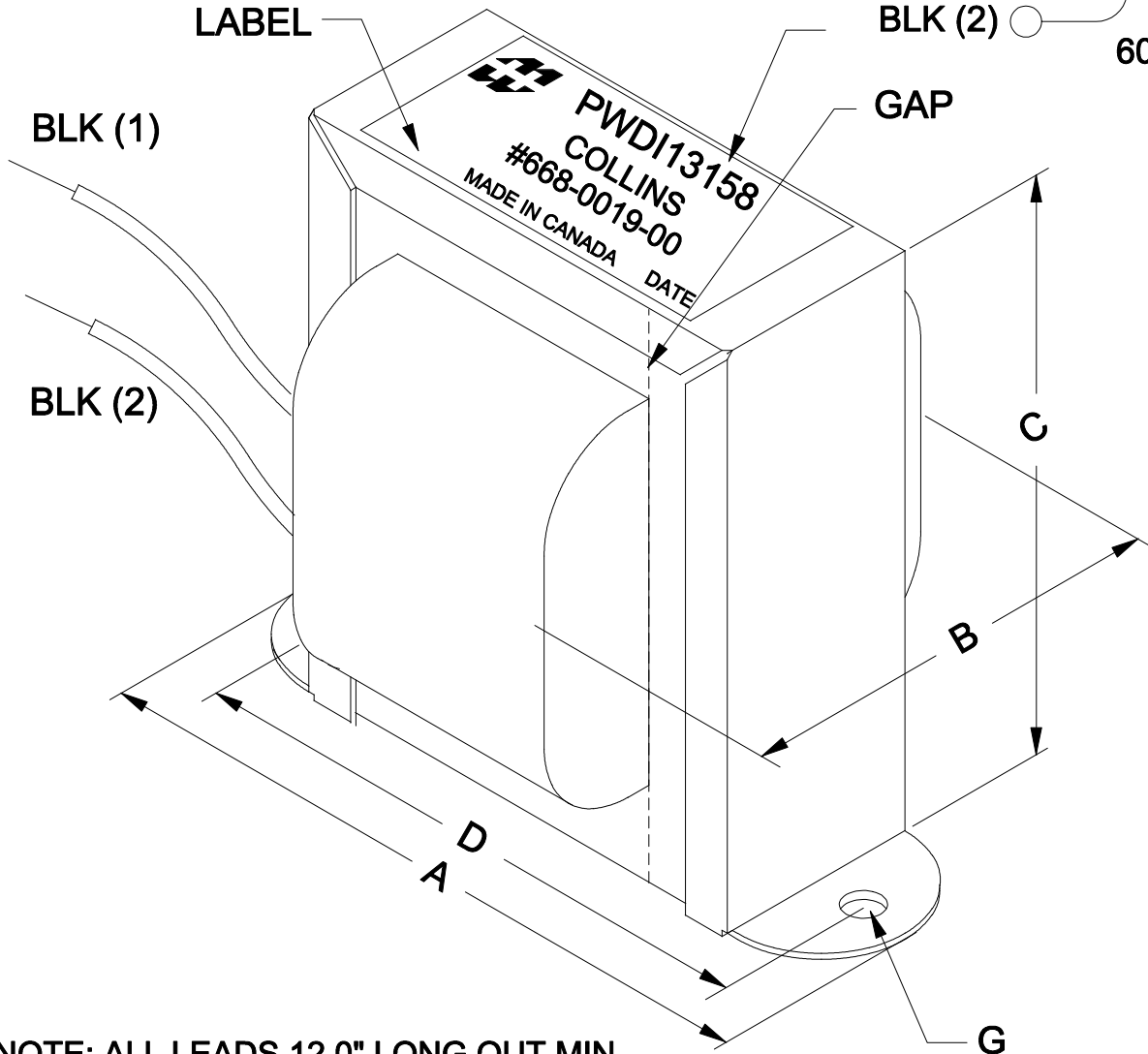

NOTE: ALL LEADS 12.0" LONG OUT MIN.
DIELECTRIC STRENGTH TEST WINDING TO CORE: 2500V, 60Hz, 1SEC.

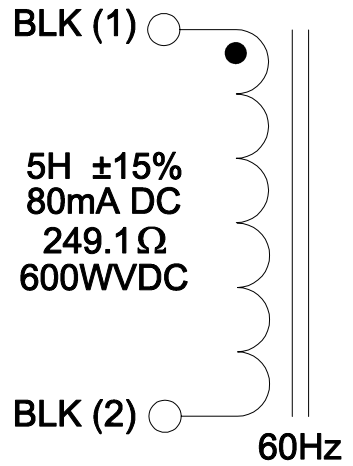

ELECTRONIC DIVISION
52 RANKIN PLACE,
WATERLOO, ONTARIO, N2J 3Z5
PH # (519) 886-6181
FAX # (519) 886-9540

TITLE
INDUCTOR
COLLINS #668-0019-00

NO	DATE	REVISION	DWG. BY
0	05/22/19	RELEASED.	C. ILIE
			DATE
			05/22/19
			DIM IN(X)MM()

PWDI13158