

SECTION B-B

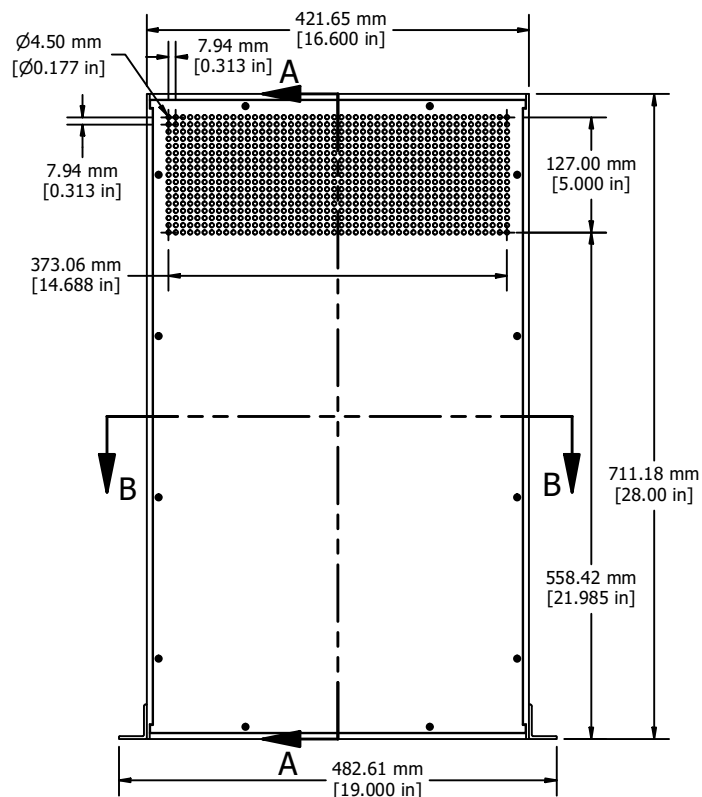

ASSEMBLY - TOP VIEW

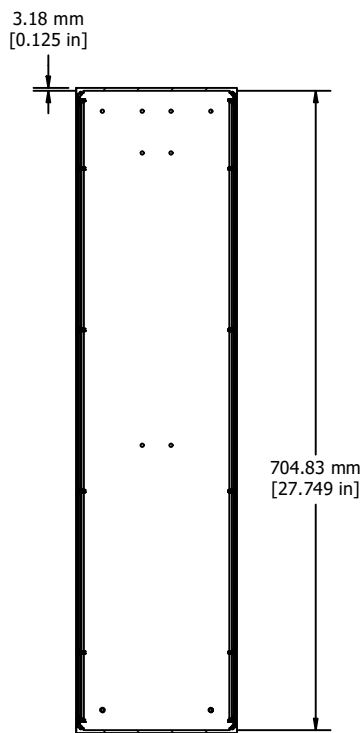

SECTION A-A

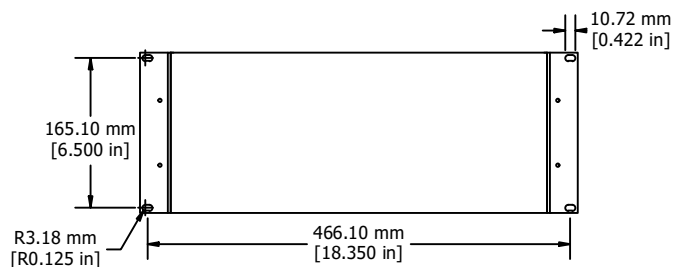

ASSEMBLY - FRONT VIEW

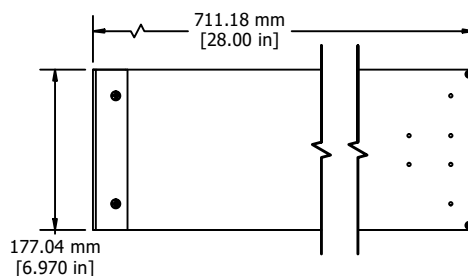

ASSEMBLY - SIDE VIEW

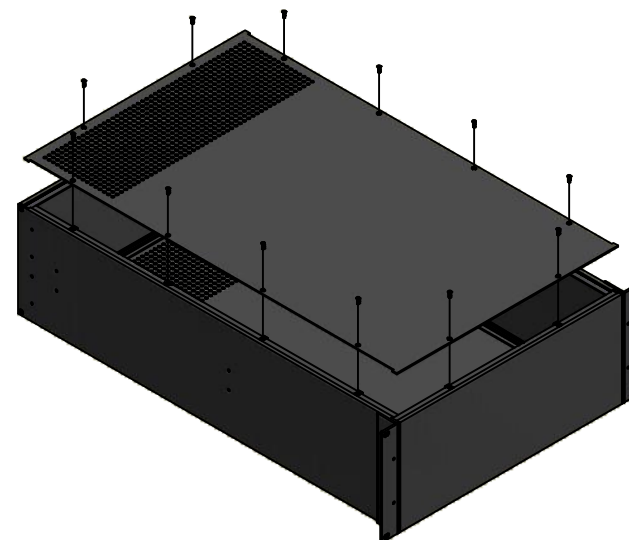

EXPLODED ISOMETRIC VIEW

Enclosures can be Factory Modified (Milling, Drilling, Printing etc.)
 Contact Factory - mjm@hammondmfg.com for quotes
 Solid models of this enclosure available in STEP or IGES.

RM4U1928VBK	
Extruded Aluminum Frame - Type 6063	
2 Panels - .064" Aluminum (5052-H32) Powder Coat	
2 Mounting Brackets - .125" Aluminum	
24 Screws - Flat Head 4-40 x 3/8"	
8 Screws - Counter Sunk Head 6-32 x 3/8"	
4 Screws - Counter Sunk Head 10-32 x 3/8"	
24 Nuts - #4 Speed Nuts	
Four Self Adhesive Rubber Feet - 1421T3	
ACCESSORIES	
PULL HANDLES	1427P1BK
REAR BRACKET KIT	RM3U18BRKT



**HAMMOND
 MANUFACTURING™**

RM4U1928VBK

www.hammondmfg.com