

DETAIL D

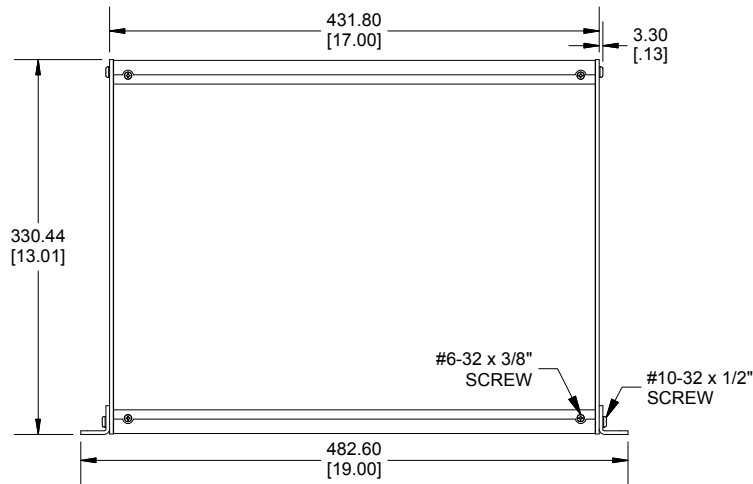

TOP VIEW

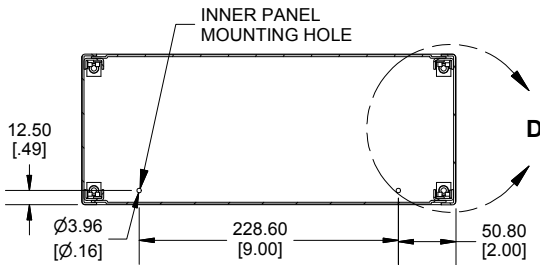
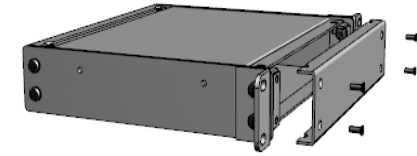

**SECTION C-C
INSIDE SIDE VIEW**

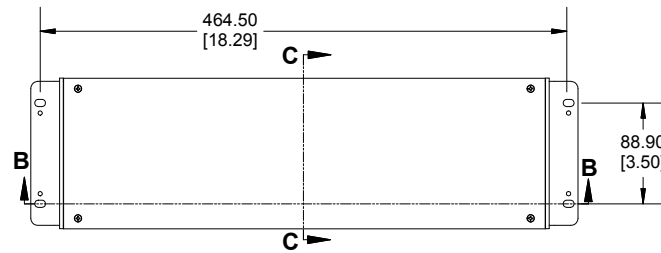

FRONT VIEW

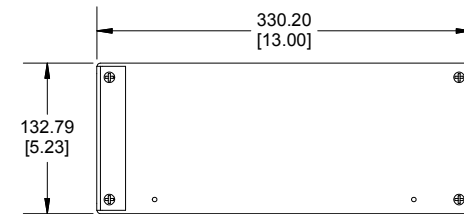

SIDE VIEW

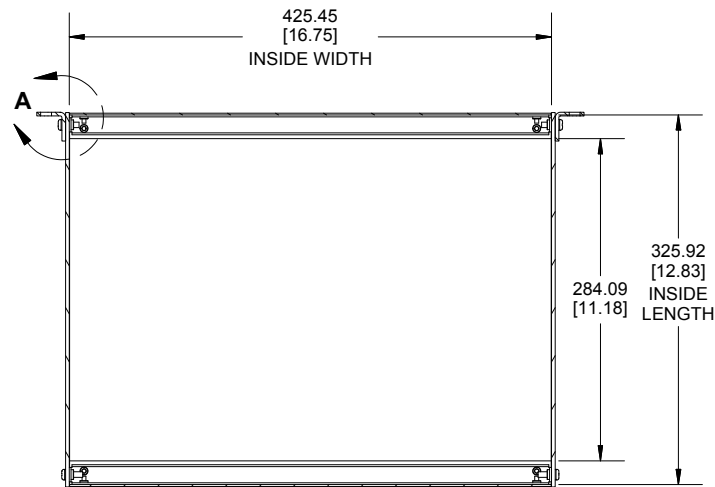

**SECTION B-B
INSIDE BOTTOM VIEW**

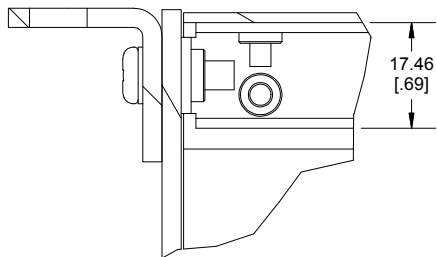

DETAIL A

Enclosures can be Factory Modified (Milling, Drilling, Printing etc.)
 Contact Factory mjm@hammondmfg.com for quotes
 Solid models of this enclosure available in STEP or IGES.
 (Part number and text placement/orientation on our products are subject to change,
 we do not recommend using them as a locating reference for modification purposes)

NOTE	
Purchased assembly includes: 2 front/rear panels, 2 top/bottom panels, 2 side panels, 2 mounting tabs, 4 inner brackets, 24 screws and 4 rubber feet. Product is not assembled for shipping purposes.	
Recommended Cover screw torque -- 8.9-9.4 lbf-in (100-110 cN-m)	

RMCS	
RMCS190513 Regular Enclosure	
Economy Rack Chassis Black	RMCS190513BK1
Economy Rack Vented Chassis Black	RMCS190513BK1
ACCESSORIES	
Inner Panel	RMP1913
Front & Rear Panel	RMCP5 (Textured Black)
	RMCP5BK (Smooth Black)
	RMCP5CG (Beige)
Inner Panel screws Black (#6-32 1/2) (50 pkg)	SC536BK-50
Replacement Hardware Kit: #10-32 X 5/8" Pan head black, qty 8 #6-32 X 3/8" Flat head black, qty 16 20.5 X 20.5 X 7.6 Rubber Bumpon, qty 4	
	RMCHDWKIT

Dimensions:
mm
[inches]

**HAMMOND
MANUFACTURING**

RMCS190513

www.hammondmfg.com