

**TOP VIEW**

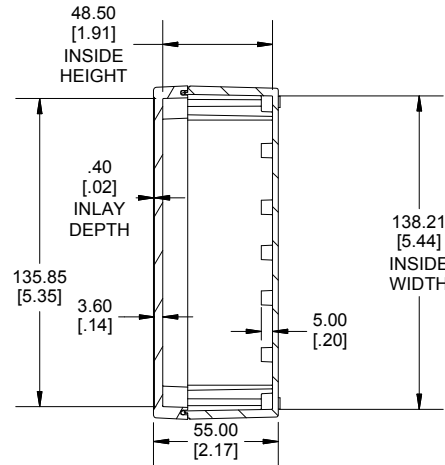

**END VIEW SECTION A-A**

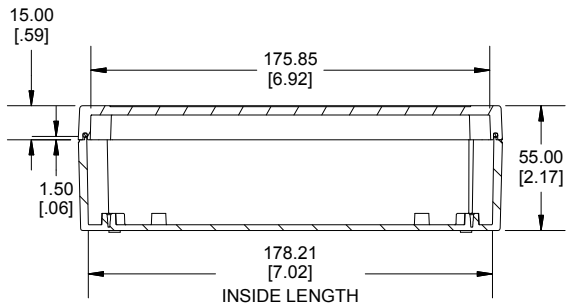

**SIDE VIEW SECTION B-B**

ACCEPTS M3 SELF-TAPPING SCREW

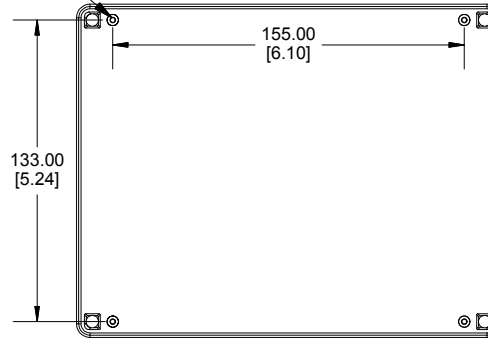

**MOUNTING HOLES**

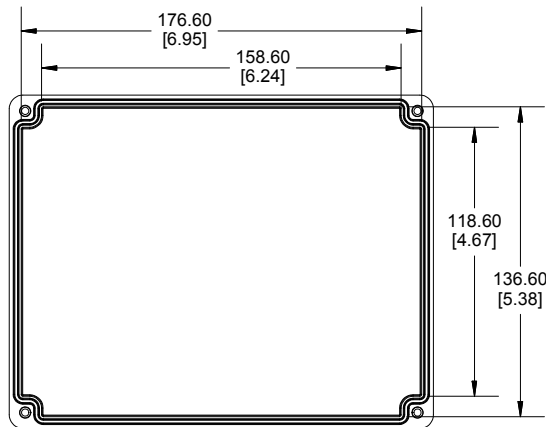

**INSIDE LID**

ACCEPTS M3 SELF-TAPPING SCREW

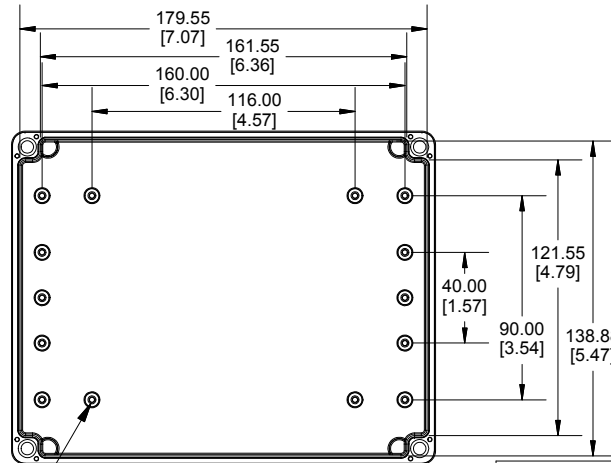

**INSIDE BOX**

Dimensions:  
mm  
[inches]

Enclosures can be Factory Modified (Milling, Drilling, Printing etc.)  
Contact Factory ([modshop@hammondmfg.com](mailto:modshop@hammondmfg.com)) for quotes  
Solid models of this enclosure available in .stp or .x\_t  
(Part number and text placement/orientation on our products are subject to change, we do not recommend using them as a locating reference for modification purposes)

**NOTE**

Purchased assembly includes box, lid, string gasket, 4 PCB screws, and 4 lid screws.

Recommended Torque : (43-50) Ozf.in / (30-35) cN.m

**RP Enclosure**

General Purpose ABS Light Grey (UL94 HB)	RP1275
General Purpose ABS Light Grey with Polycarbonate Clear Lid (UL94 HB)	RP1275C
Polycarbonate Off-White (UL94-V2)	RP1270
Polycarbonate Off-White with Clear Lid (UL94-V2)	RP1270C

**ACCESSORIES**

Lid Screw (M3.5-0.6 X 10mm) (50 Pkg)	SC619-50
PCB Screw (M3 X 6mm Self-tapping) (50 Pkg)	SC622-50
General Purpose ABS Black Inner Panel 3mm Thick	STC128
Metal Inner Panel 1mm Thick	STA128
String Gasket EPDM Grey (2 Pkg)	RP128GASKET

**HAMMOND MANUFACTURING**

**RP127**

[www.hammondmfg.com](http://www.hammondmfg.com)