

P.C. Board Mount (601-610 Series)



PULSE TRANSFORMERS

- These ferrite cored transformers are fully encapsulated in a high grade black molded case with a UL94V-O rating.
- Used in digital and data processing, line coupling, matching, isolation etc.
- Working voltage rating maximum of 500V D.C.
- ET values up to 50V uS.

Part No.	Turns Ratio +/- 2%	Primary Inductance uH (min)	Primary ET Constant V uS	Inter W Capacity pf. Ref.	Leakage Inductance uH (max.)	D.C. Resistance Ohms max.	Cir. Dia.
601A	1:01	2060	17.5	45	0.6	1.5	B
601B	1:01	492	8.5	20	0.3	0.8	B
601C	1:01	219	5.5	12	0.25	0.5	B
601D	1:01	50	4	10	0.2	0.4	B
601F	1:01	9.5	6	10	0.2	0.4	B
602A	1:01:01	2060	17.5	35	0.6	1.5	C
602B	1:01:01	492	8.5	20	0.3	0.8	C
602C	1:01:01	219	5.5	12	0.25	0.5	C

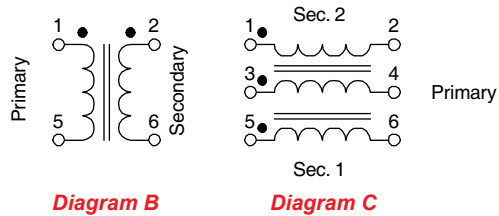
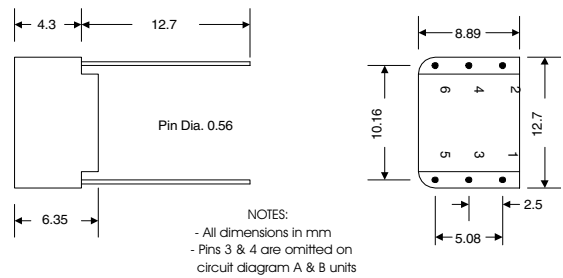

610A Dimensions & Schematic

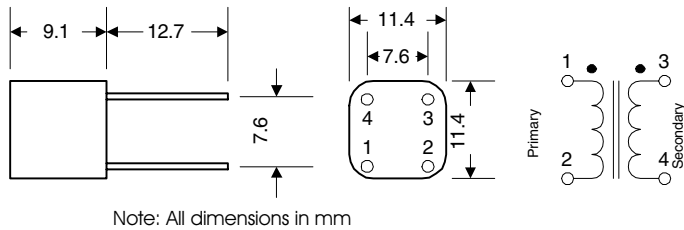

610B Dimensions & Schematic

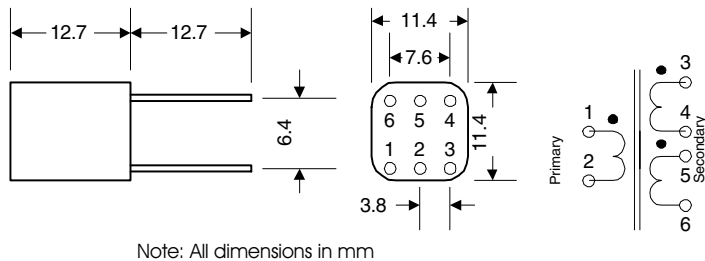

PULSE TRANSFORMERS

- These ferrite cored transformers are fully encapsulated in a high grade black molded case with a UL94V-O rating.
- Units are intended for wide band and pulse applications including thyristor / triac firing circuits.
- Peak pulse voltage rating maximum of 250V.
- Insulation tested to 1,000V RMS.

Part No.	Ratio	Primary		Secondary Resistance		Primary ET Constant V (uS).	Leakage Inductance uH (max.)	Max. Primary or Secondary Peak Current	
		Inductance mH (min)	Resistance Ohms	Sec. 1 (Ohms)	Sec. 2 (Ohms)			@ 10% Duty	@ 1% Duty
610A	1:01	3.9	3.4	3.9	-	500	60	0.2A	0.6A
610B	1:01	2.7	2.1	2.1	2.3	500	50	0.2A	0.6A

CANADA

Guelph, Ontario (519) 822-2960
St. Laurent, Quebec (514) 343-9010

USA

Cheektowaga, NY (716) 630-7030

www.hammondmfg.com



EUROPE

Basingstoke, UK 01256 812812

AUSTRALIA

Queenstown, Australia 61-8-8240-2244

P.C. Board Mount (610-611 Series)

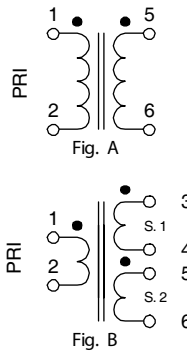
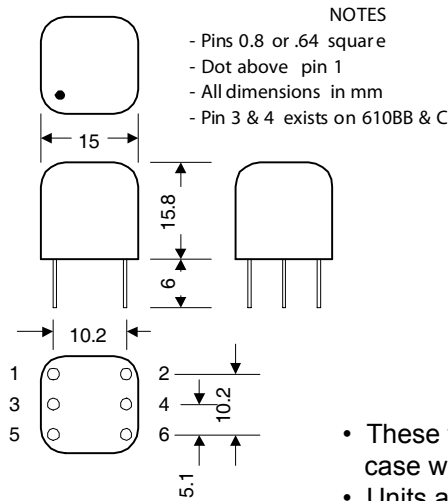

PULSE TRANSFORMERS

- These ferrite cored transformers are fully encapsulated in a high grade black molded case with a UL94V-O rating.
- Units are intended for wide band and pulse applications including thyristor / triac firing circuits, signal isolation, line matching, low power switch mode power supplies, etc.
- Working voltage rating maximum of 500V RMS
- All units are voltage proof tested to 2.0KV peak 50 Hz.

Part No.	Ratio	Primary		Leakage Inductance uH (max)	Capacity pf. (Ref)	D.C. Winding Resistance			Sch. Fig #
		Inductance mH (min)	ET Constant V (uS)			Pri (Ohms)	Sec. 1 (Ohms)	Sec. 2 (Ohms)	
610AA	1:01	3	200	22	23	1.2	1	-	A
610BB	1:01	3	200	9	28	1.4	1.3	1.7	B
610C	2:01	12	400	35	30	4	1.8	2.4	B

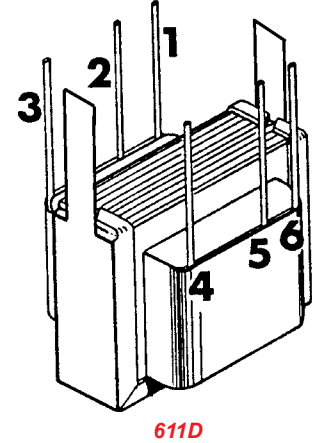
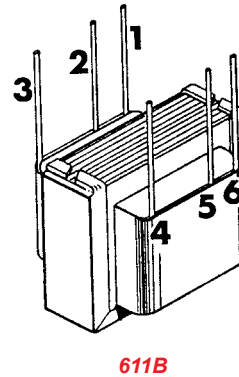
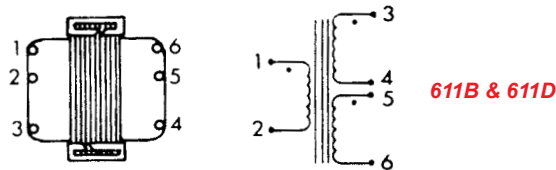
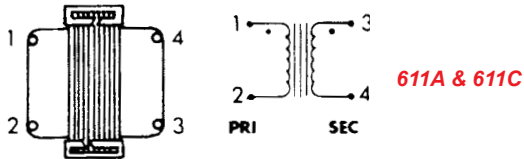

PULSE TRANSFORMERS

- Economical, open style, P. C. board pin mount
- Units are intended for pulse applications including thyristor / triac firing circuits.

Part No.	Ratio	Circuit Max. volts	Primary ET Constant V (uS)	Primary		D.C. Winding Resistance		Max. Primary or Secondary Peak Current		Insulation RMS (Volts)	Wt. Oz.
				Inductance mH (min)	D.C. Res. (Ohms)	Sec. 1 (Ohms)	Sec. 2 (Ohms)	@ 10% Duty	@ 1% Duty		
611A	1:01	125	1400	8.6	0.45	0.55	-	0.7 A	2.1 A	1000	0.7
611B	1:01	125	1400	17.2	1.26	1	1.53	0.7 A	2.1 A	1000	0.7
611C	1:01	250	7250	56	3.31	4.46	-	0.7 A	2.1 A	1500	1.2
611D	1:01	250	4000	17	1.73	1.31	2.12	0.7 A	2.1 A	1500	1.2

Part No.	Pin Spacing	Height	Width	Coil Depth	Mounting Tab	
					Centers	Size
611A & 611B	0.2" x 0.6"	.69"	.82"	.57"	-	-
611C & 611D	0.2" x 0.6"	.82"	1.06"	.82"	1"	.12" x .25"

EUROPE
Basingstoke, UK 01256 812812

AUSTRALIA
Queenstown, Australia 61-8-8240-2244

www.hammondmfg.com



CANADA
Guelph, Ontario (519) 822-2960
St. Laurent, Quebec (514) 343-9010
USA
Cheektowaga, NY (716) 630-7030



Pulse

Chassis & P.C. Board Mount (612, 630-632 Series)

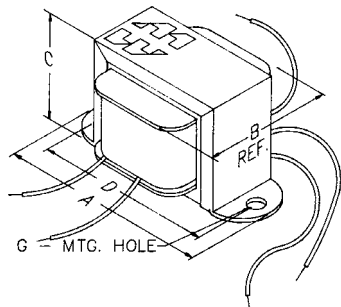

PULSE TRANSFORMERS

- Economical, open style, chassis mount.
- Mounting hole (G) - .187"
- Units are intended for pulse applications including thyristor/triac firing circuits.
- Flexible leads - 4" minimum.

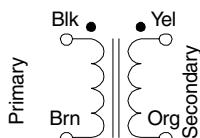

612G

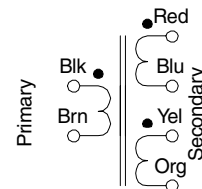

612H

Part No.	Ratio	Circuit Max. Volts	Primary ET Constant V (uS)	Primary		D.C. Winding Resistance		Max. Primary or Secondary Peak Current		Insulation RMS (Volts)	Wt. Oz.	Dimensions (Inches)			
				Inductance mH (min.)	D.C. Res. (Ohms)	Sec. 1 (Ohms)	Sec. 2 (Ohms)	@ 10% Duty	@ 1% Duty			A	B	C	D
612G	1:01	600	4500	6.6	0.87	0.87	-	0.9 A	2.8 A	4000	8	2.06	1.25	1.19	1.75
612H	1:01	600	2300	1.5	0.45	0.42	0.49	0.9 A	2.8 A	4000	8	2.06	1.25	1.19	1.75

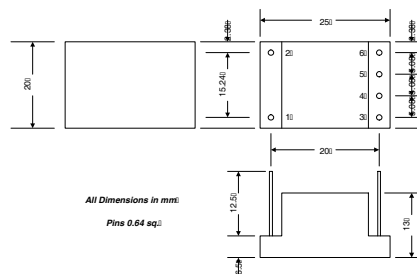
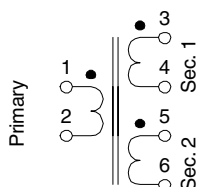

PULSE TRANSFORMERS

- These transformers are fully encapsulated in a high grade black molded case with a UL94V-O rating.
- They are intended mainly for thyristor / triac triggering applications.
- All units are voltage proof tested between windings at 2,500V RMS for 1 minute, for a working voltage rating maximum of 440V RMS.

Pulse

Part No.	Turns Ratio	Primary		Leakage Inductance uH (max)	Capacity pf. (max)	D.C. Winding Resistance			
		Inductance mH (min.)	ET Constant V uS			Pri. (Ohms)	Sec. 1 (Ohms)	Sec. 2 (Ohms)	Sec. 3 (Ohms)
630B	1:01	1	120	2	50	0.25	0.23	-	-
631B	1:01	1	120	3	40	0.25	0.22	0.28	-
632B	2:01	1	120	3.5	30	0.24	0.12	0.15	-
630C	1:01	4	240	5	55	0.86	0.83	-	-
631C	1:01	4	240	11	35	0.90	0.76	1.10	-
632C	2:01:01	4	240	11	35	0.84	0.38	0.50	-
630D	1:01:00	16.3	482	18	65	3.50	3.40	-	-
631D	1:01:01	16.3	482	40	40	3.60	3.10	4.20	-
632D	2:01:01	16.3	482	40	40	3.50	1.60	2.00	-



CANADA
Guelph, Ontario (519) 822-2960
St. Laurent, Quebec (514) 343-9010
USA
Cheektowaga, NY (716) 630-7030

www.hammondmfg.com



EUROPE
Basingstoke, UK 01256 812812

AUSTRALIA
Queenstown, Australia 61-8-8240-2244