

TOP VIEW

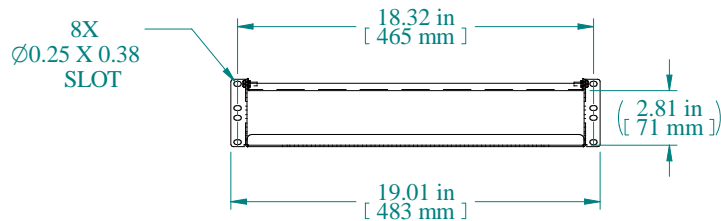

FRONT VIEW

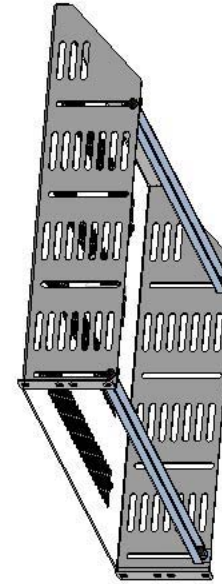
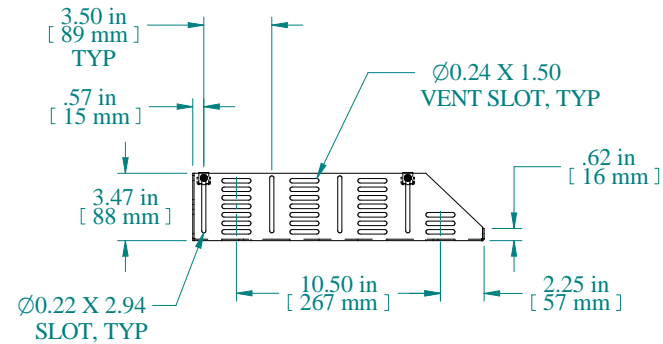

SIDE VIEW

Item Number	Title	Quantity
1	RACSV - CLAMPING SHELF (2U)	1
2	RACS - CLAMPING BRACKET	2
3	SCREW 10-32 X 5/8"	4

Data subject to change without notice. Isometric drawing not to scale.

PART NUMBERS	
RACSV190315BK1	PAINTED BLACK TEXTURED

NOTES
Maximum Weight 100 lb Hardware for Clamping Brackets Included Mounting Hardware Not Included



**HAMMOND
MANUFACTURING™**
www.hammondmfg.com
PART NO. RACSV190315